

# New Lovers' Knot

designed in 3/97 and diagrammed in 12/00

Based on traditional Lovers' Knot model

©1997, 1998 Sy Chen

1. Start from duo-color square with heart color side up

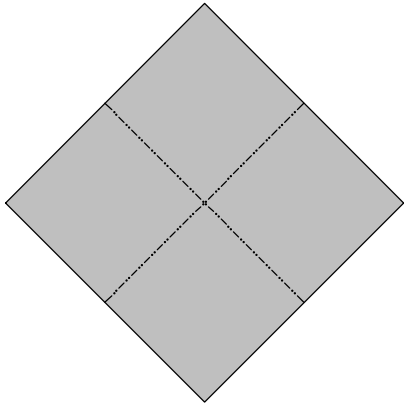

2.

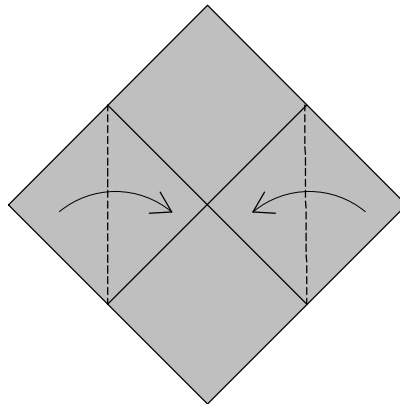

turn over

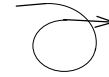

3. Enlarged

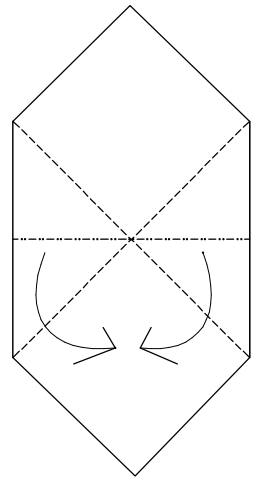

4. Enlarged; Repeat behind

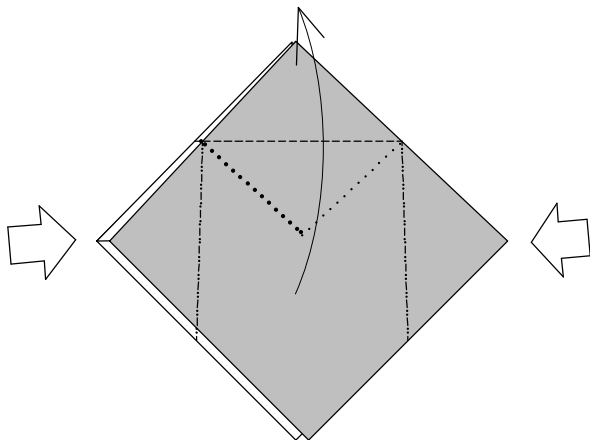

5. Change faces

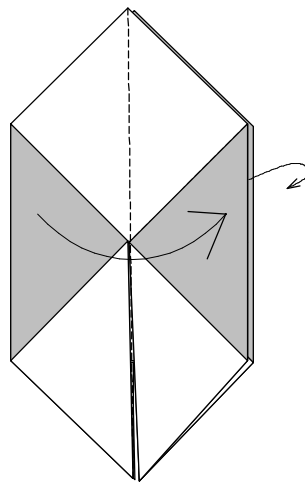

6. Repeat behind

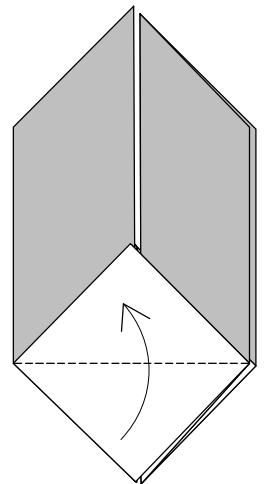

7. Change faces

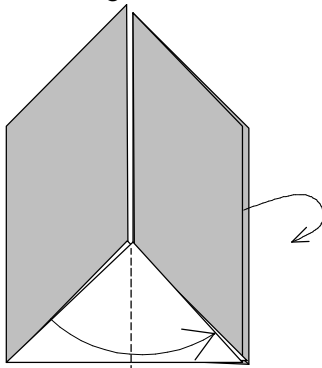

8. Repeat behind

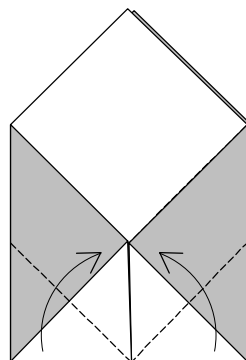

9.

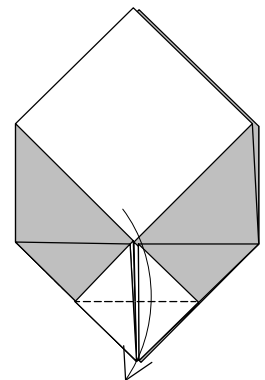

10.

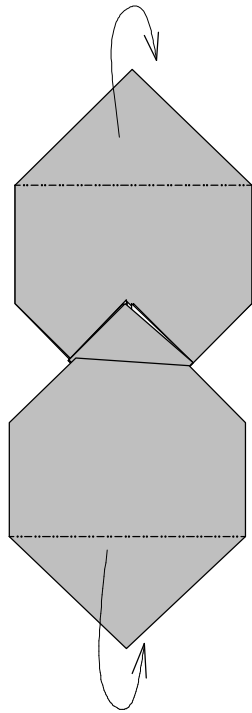

11. Pull both ends to spread the center

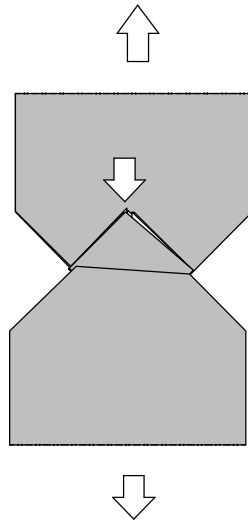

12.

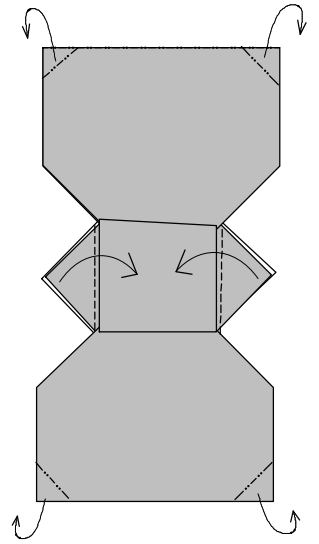

13. Indent top notch to form 3D hearts

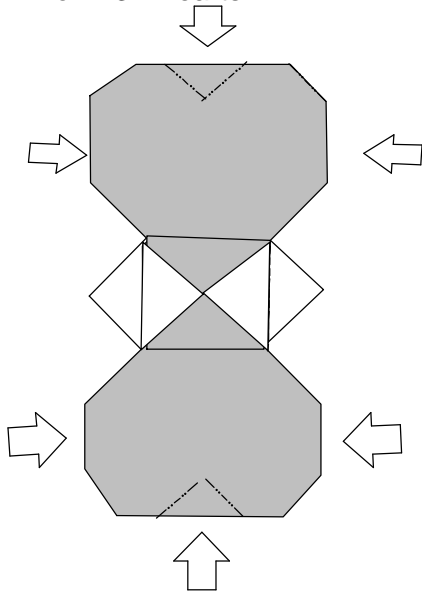

14. Finished

90°

